







MARGAUX 195

Gamme Standing

Inox 304

Finition **INOX Brossé**

	Poignée/plaque 195	
BDC	Bec de cane	IN201GM
	Clé	IN202GM
	Cylindre	IN203GM
	Condamnation	IN204GM
	Conda. Voyant	IN204GMVO
Ensemble Palière BOUTON MARGAUX		
BDC	Bec de cane	IN236B-201GM
	Cylindre	IN236CI-203GM
Ensemble Palière AMANDE MARGAUX		
BDC	Bec de cane	IN235B-201GM
	Cylindre	IN235CI-203GM
Ensemble Palière BOULE MARGAUX		
BDC	Bec de cane	IN286B-201GM
	Cylindre	IN286CI-203GM

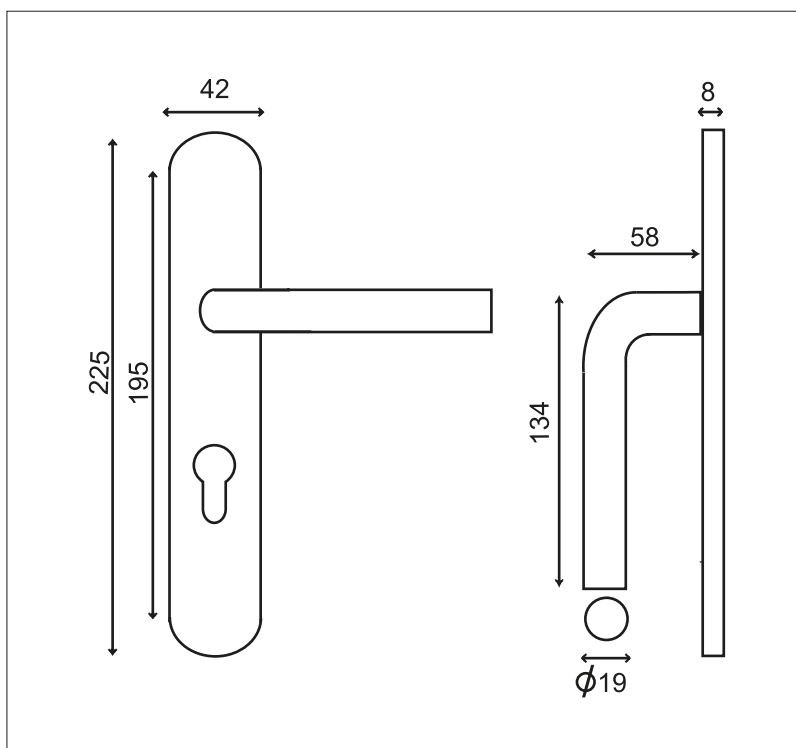

- Ressort de rappel sur toutes fonctions sauf en condamnation Voyant
- Vis de fixation invisibles grâce à une sous-plaque
- Assemblage sous-plaques par vis relieuses
- Carré de 7 et visserie fournis pour portes de 40mm d'épaisseur

Assemblage par vis sur piliers taraudés

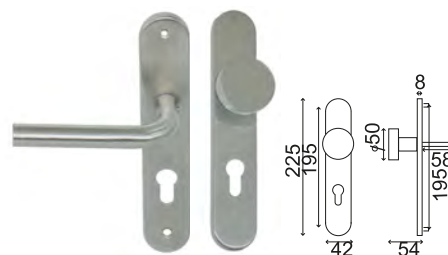

Ensemble palière BOUTON MARGAUX

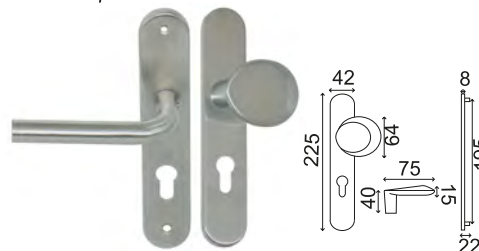

Ensemble palière AMANDE MARGAUX

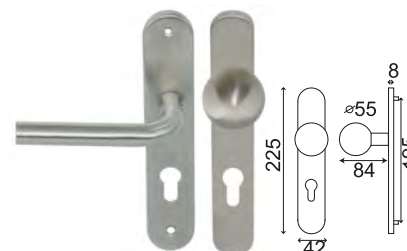

Ensemble palière BOULE MARGAUX