

MONTAGE ARMOIRE A CLES PRINCIPALE

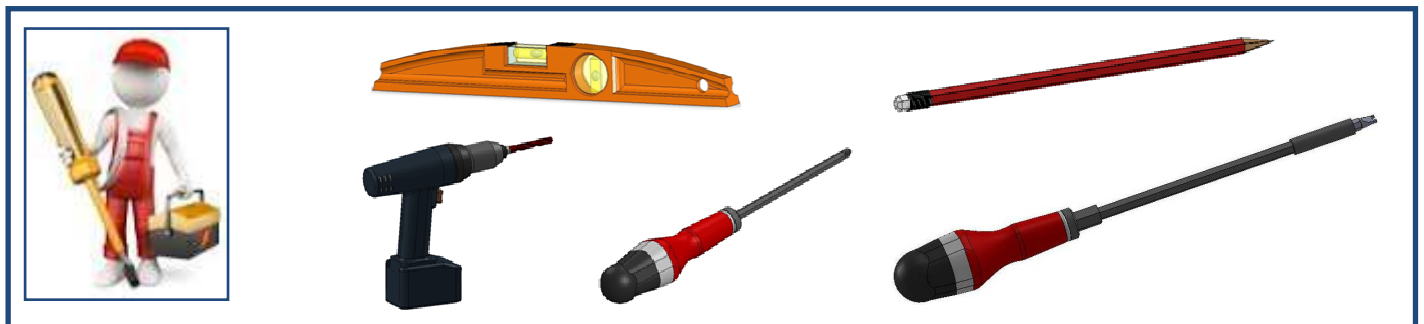

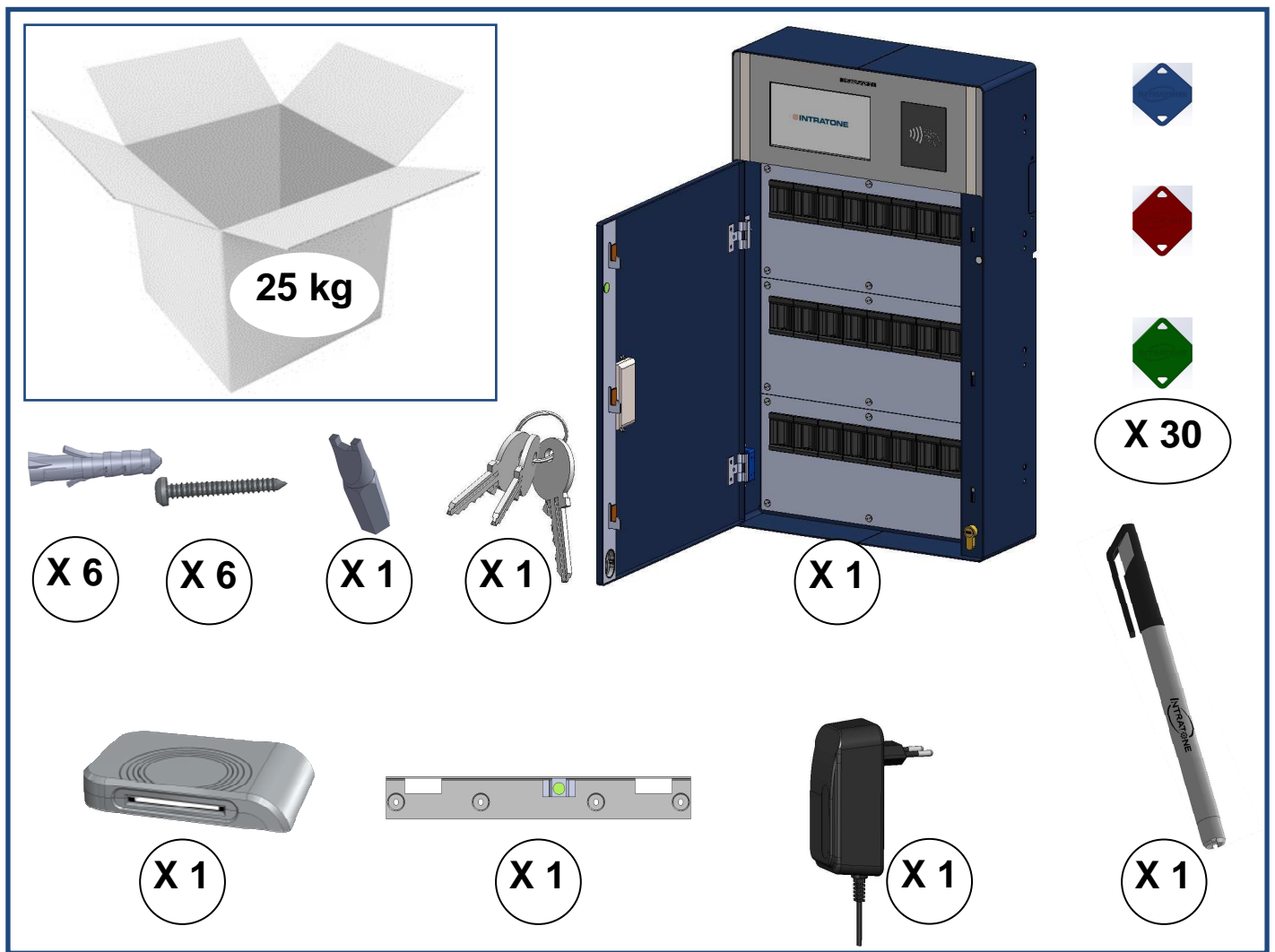

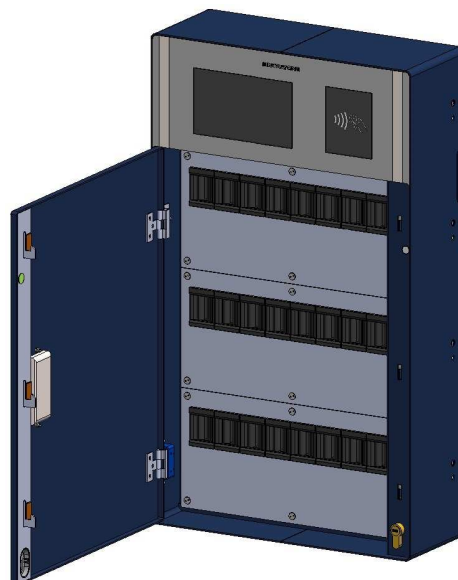
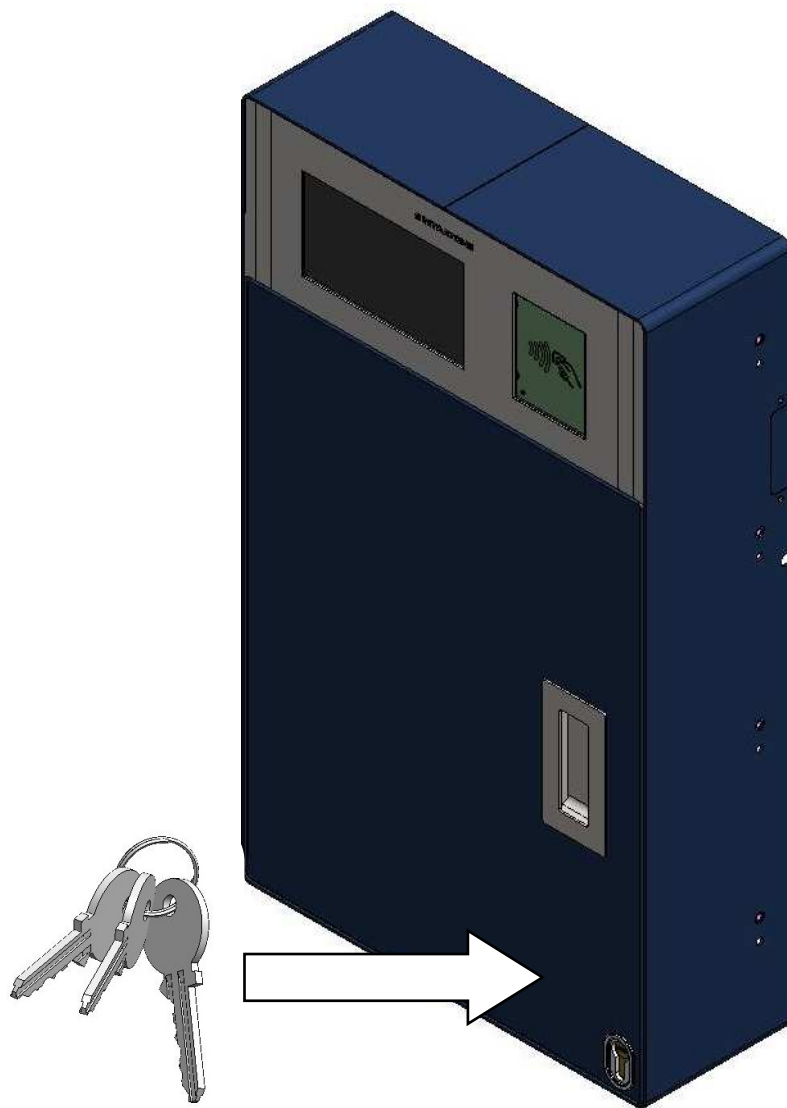
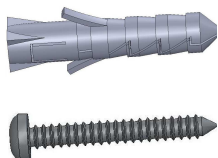
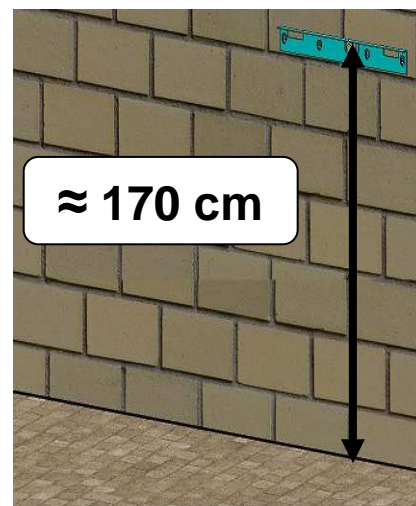
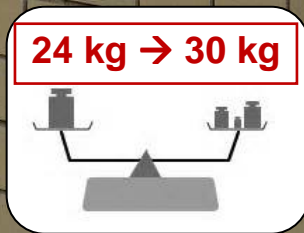
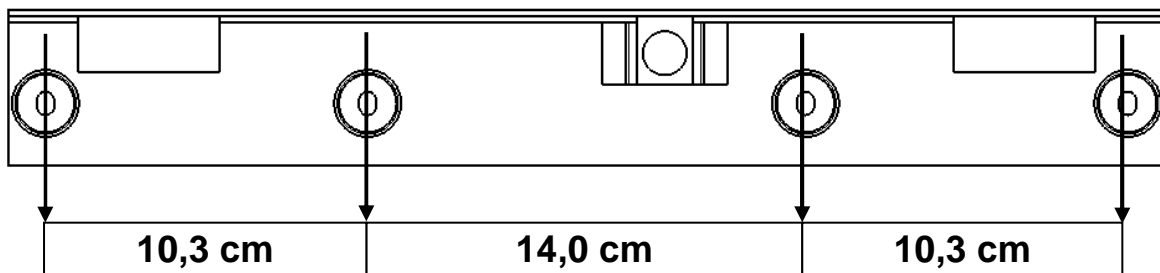
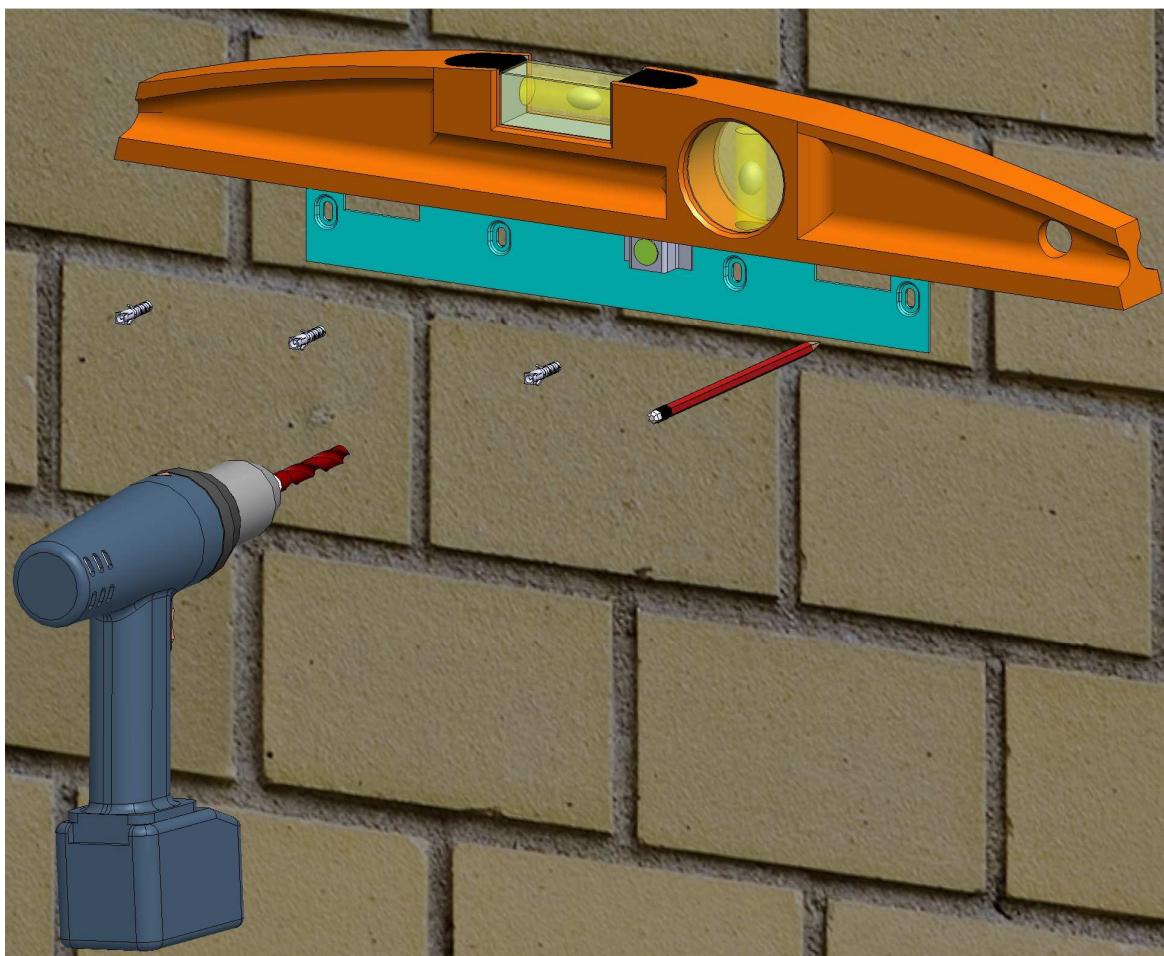

X 4

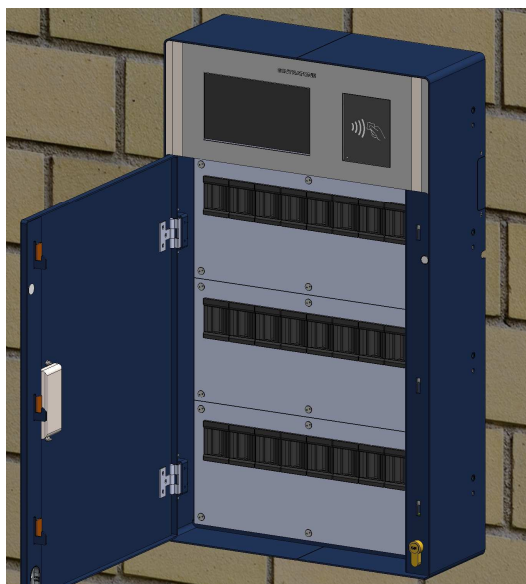
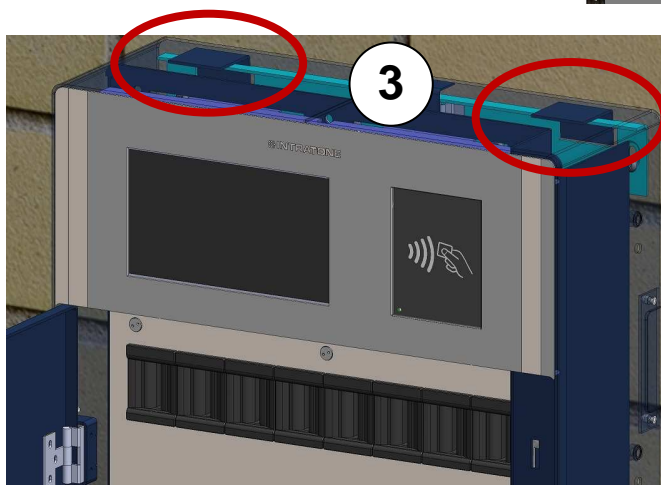
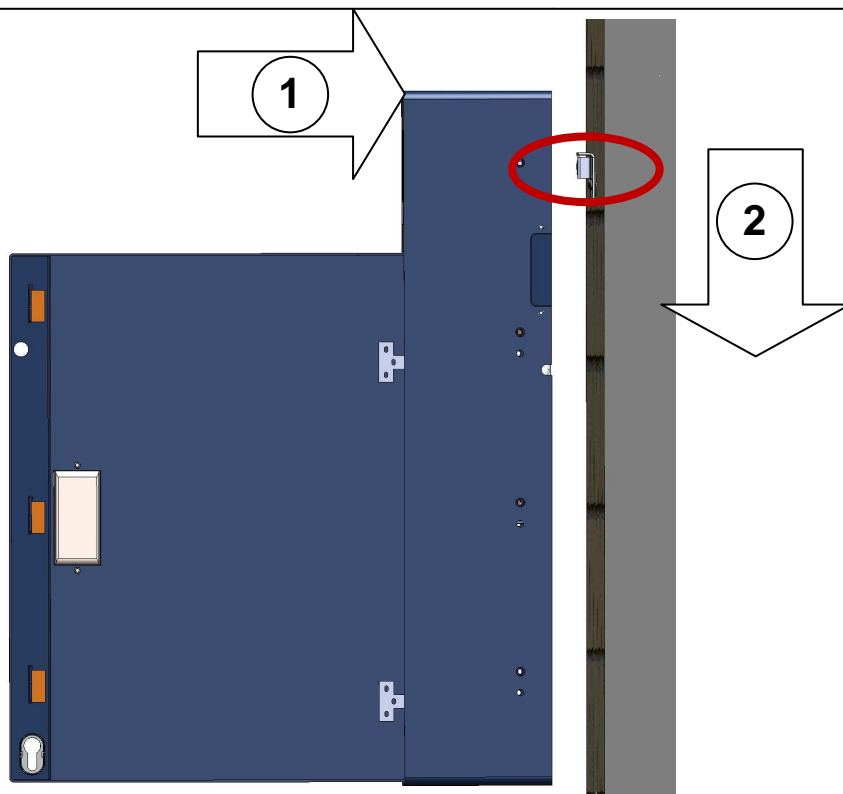

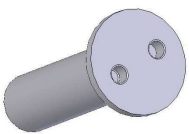
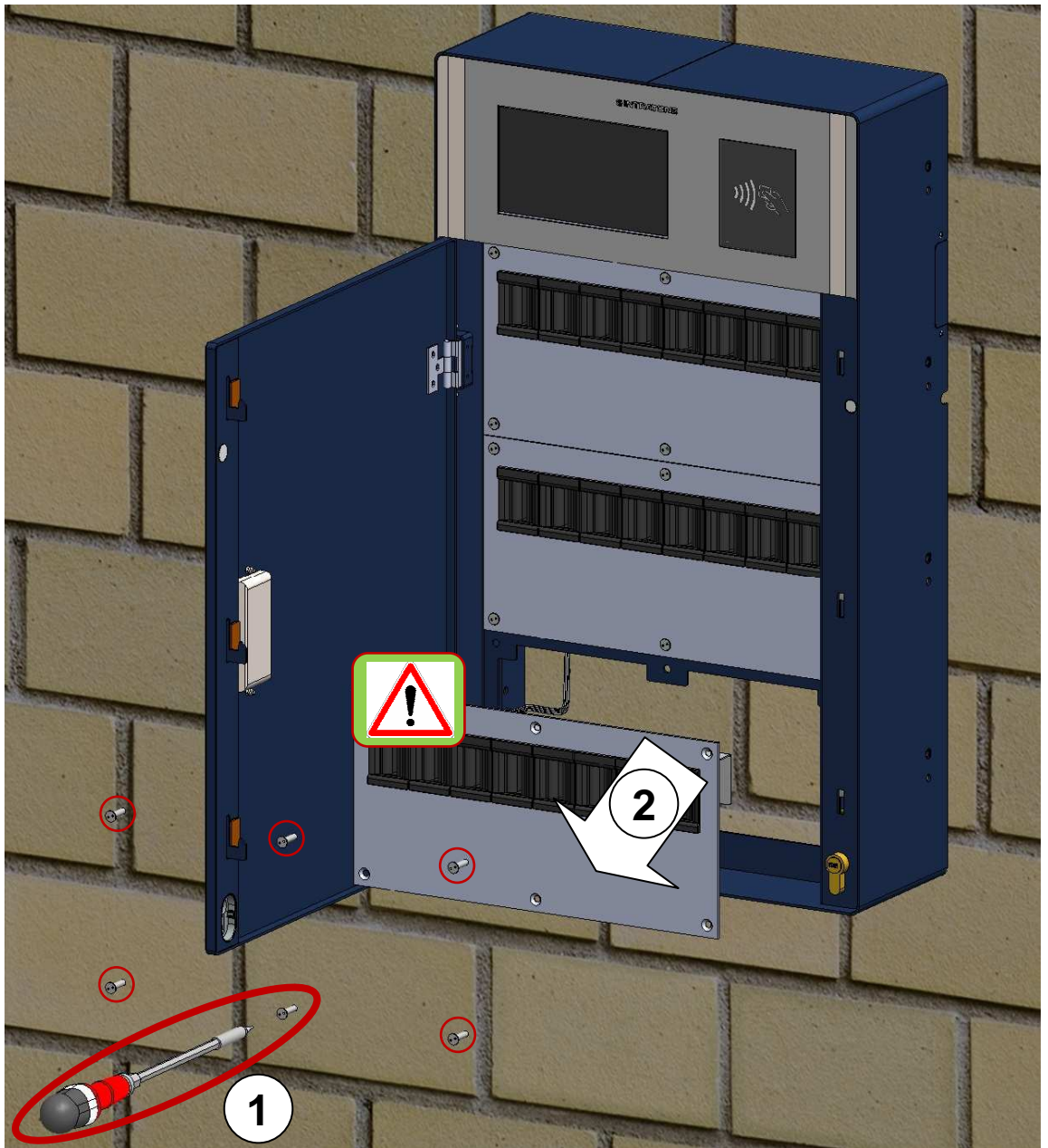

X 6

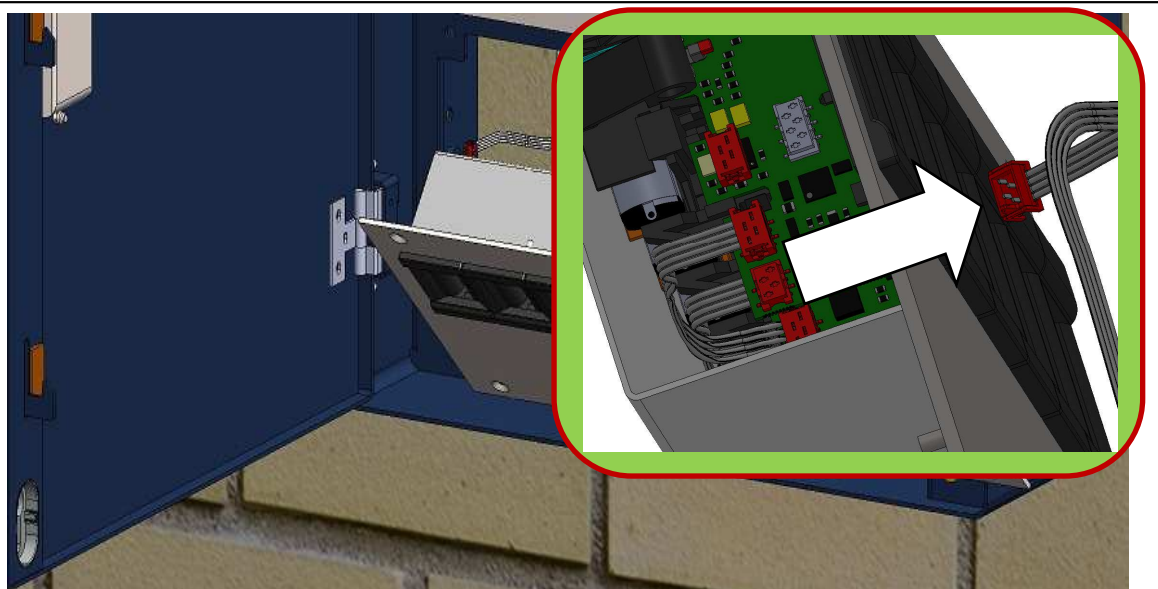

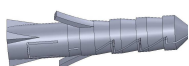
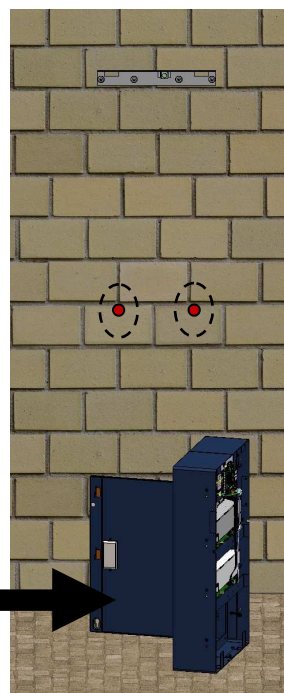
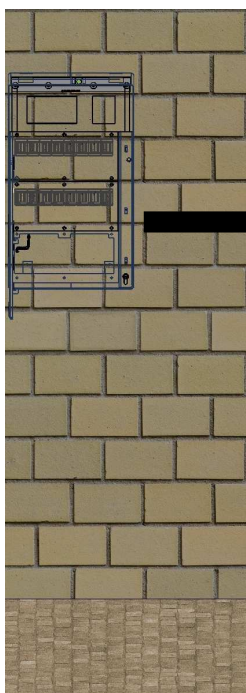
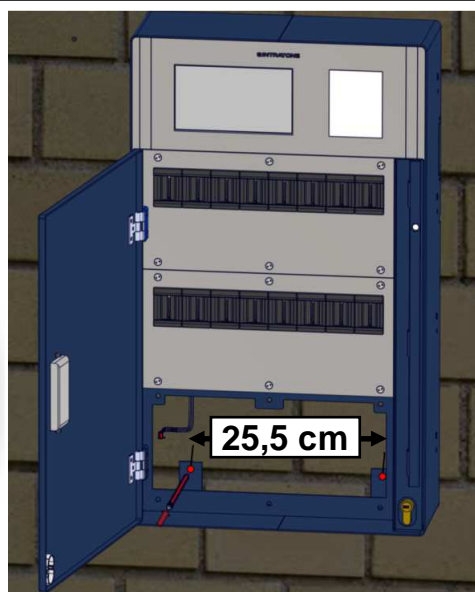
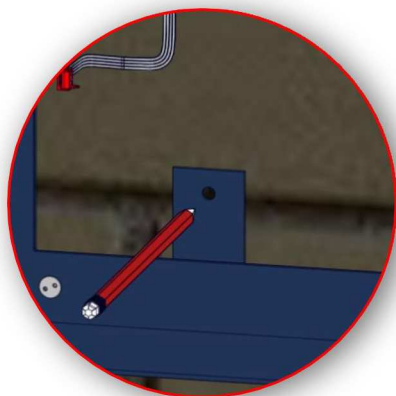

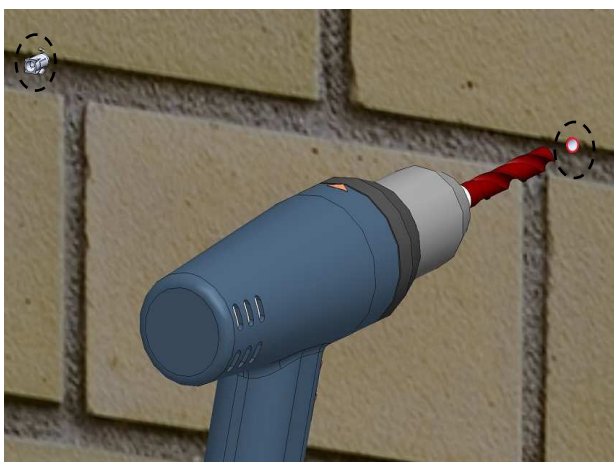

X 2

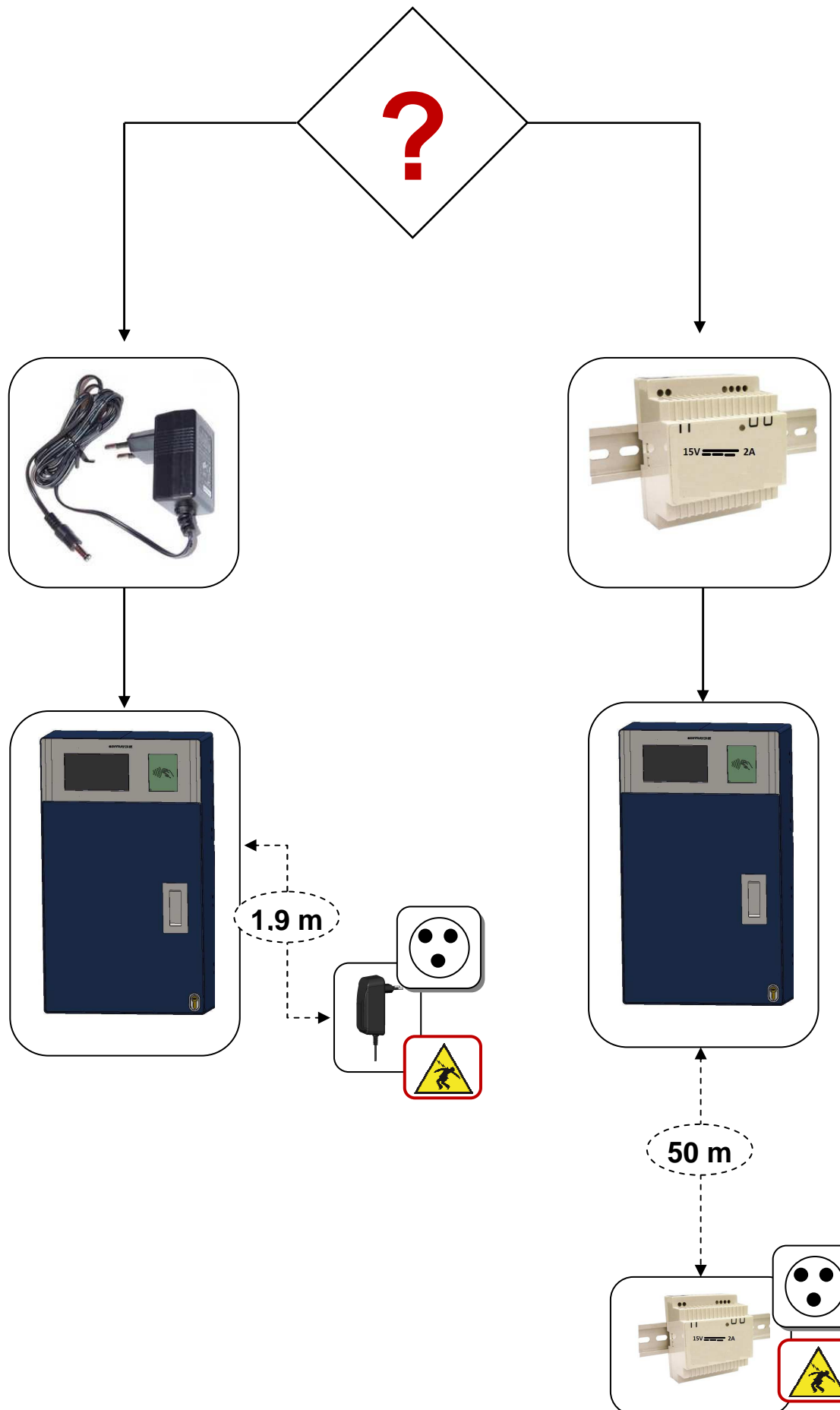

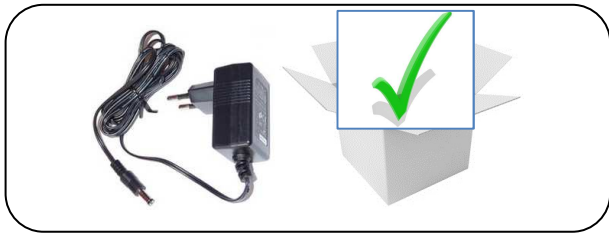



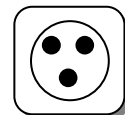
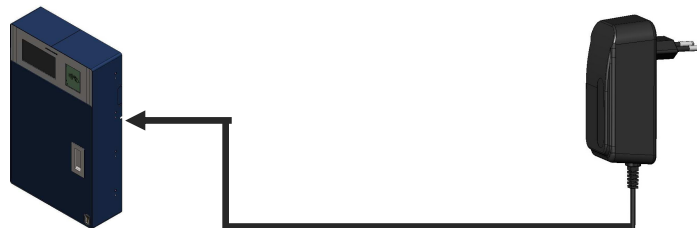
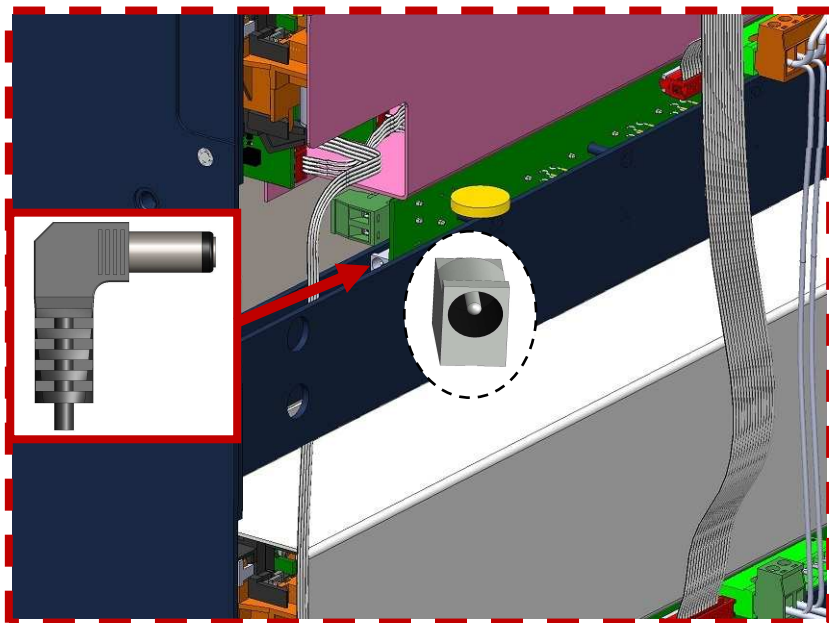
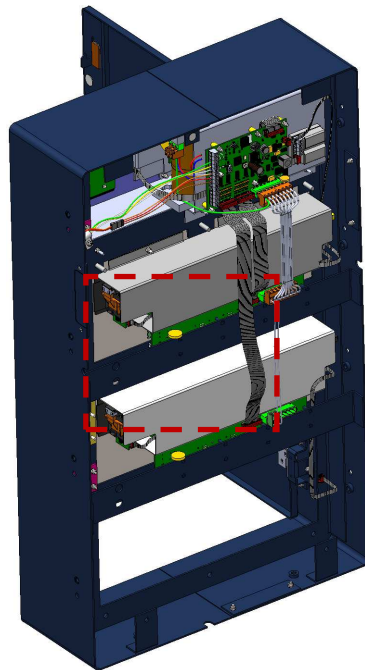

| | |
|---|-----|
| Ø | m |
| | 1,9 |

15 V DC  / 2 A

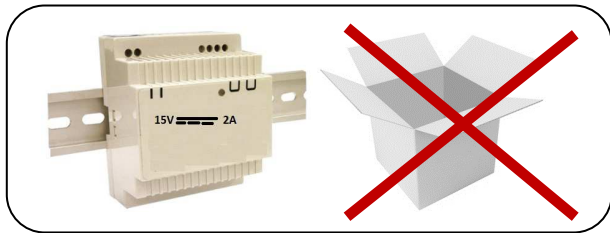



| | |
|---|----|
| Ø | m |
| 1,5 mm ² | 50 |
| 15 V DC  / 2 A | |

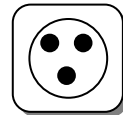
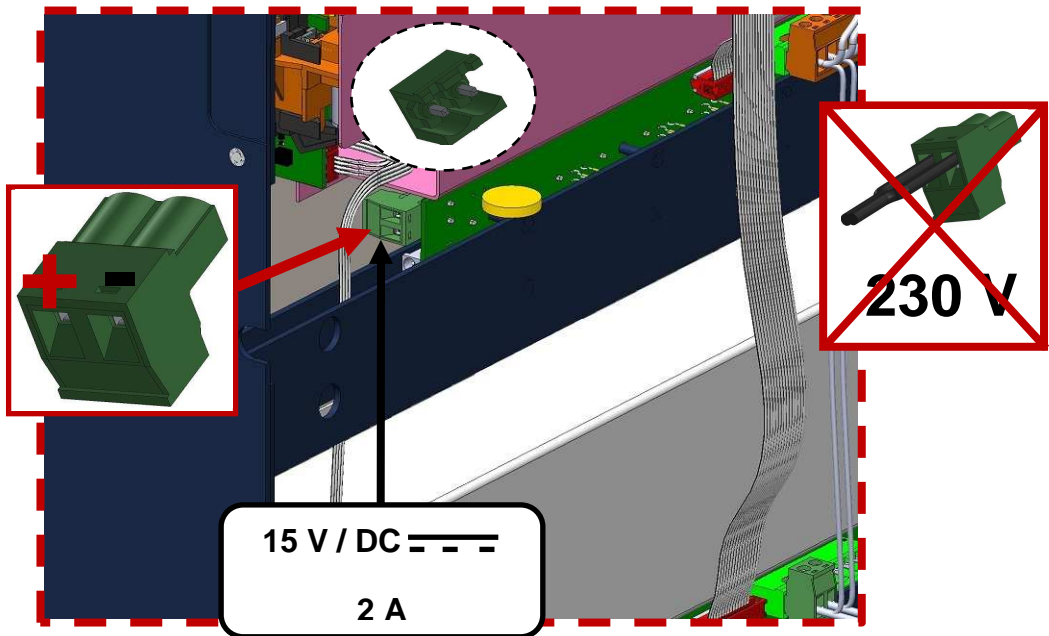
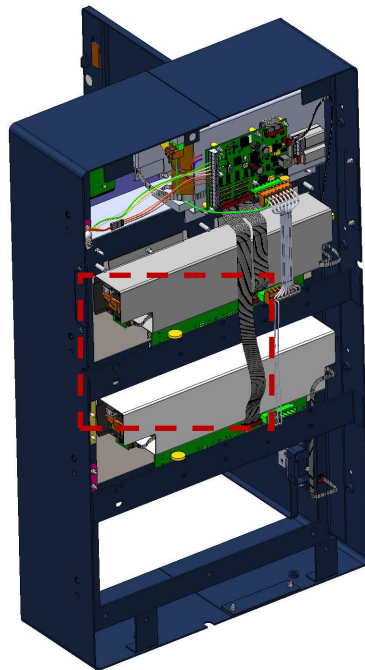

09 / 12 : Fixation de l'armoire au mur

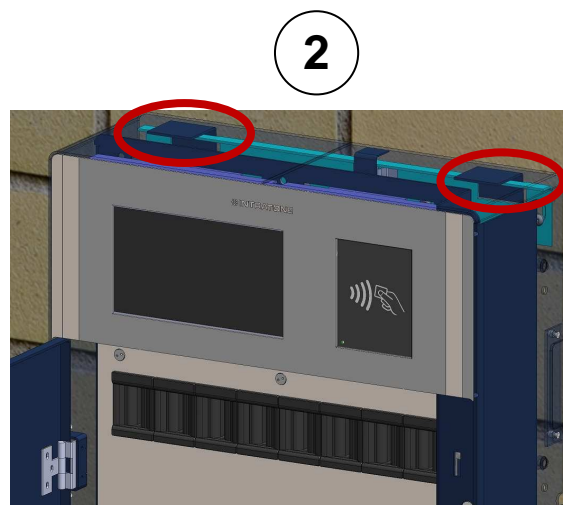
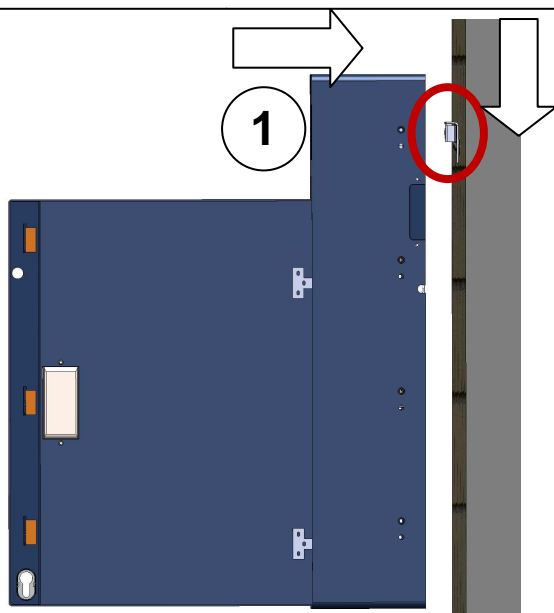

Vue armoire sur le mur ; bandeau du bas vide

3



X 2

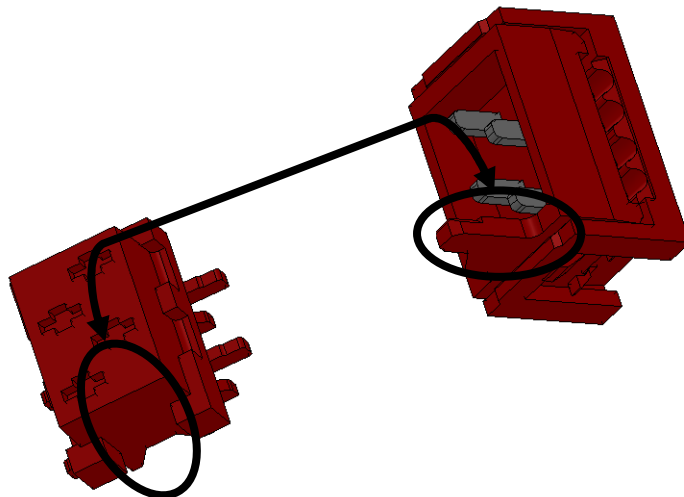
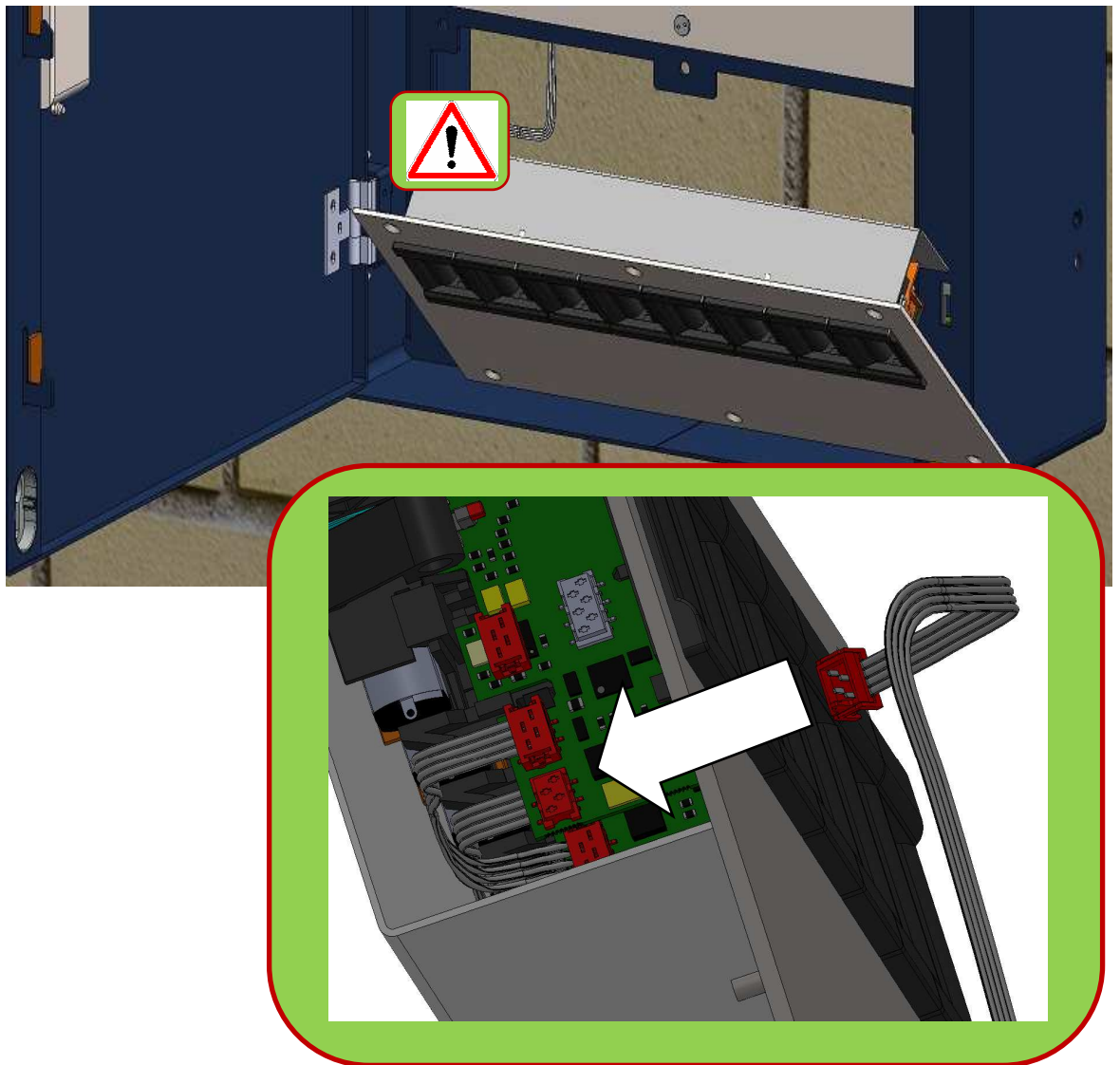

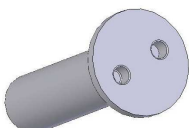
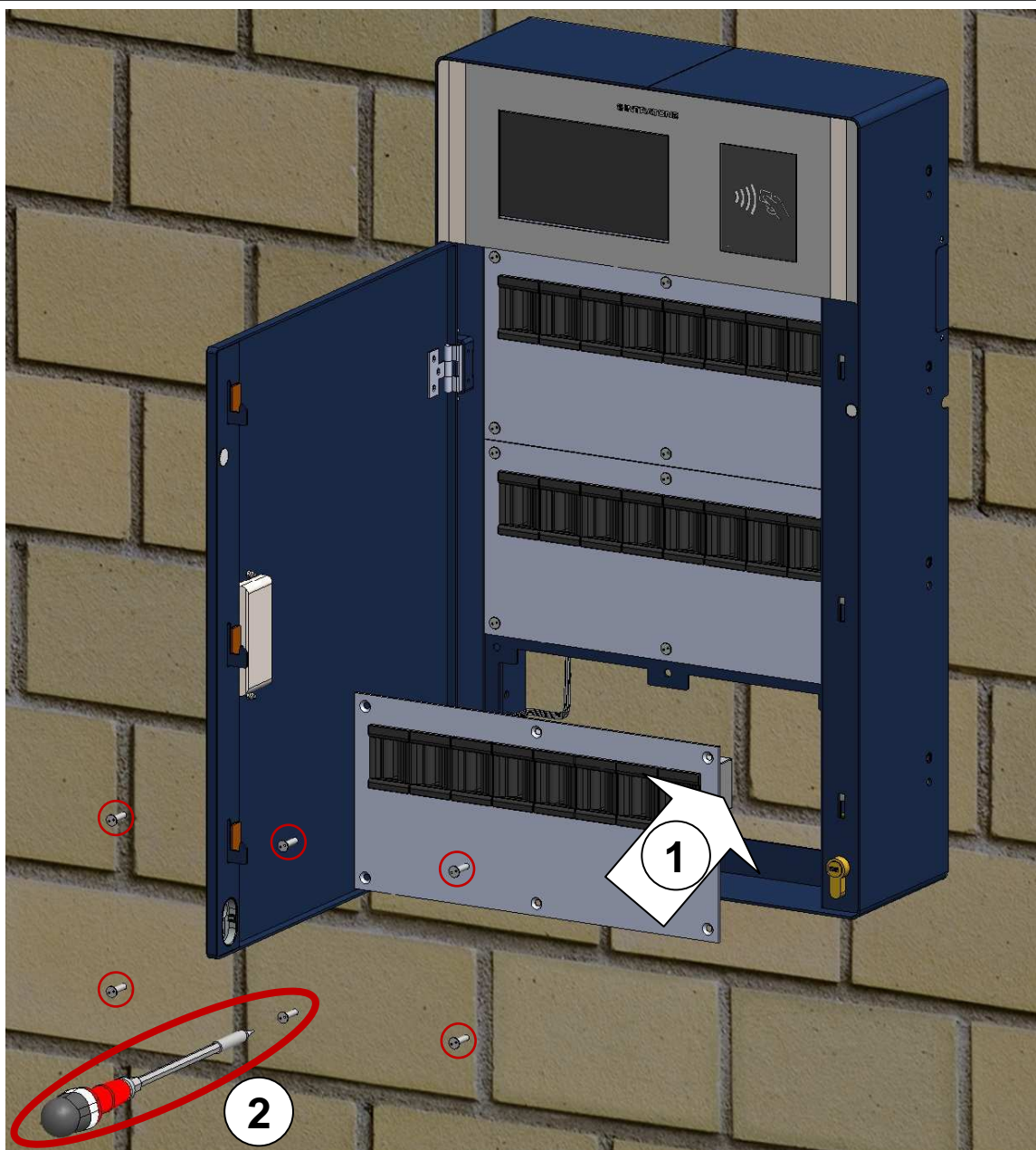

X 6

